



# Cascade

008.001.005.001





blue rabbit

© 2016

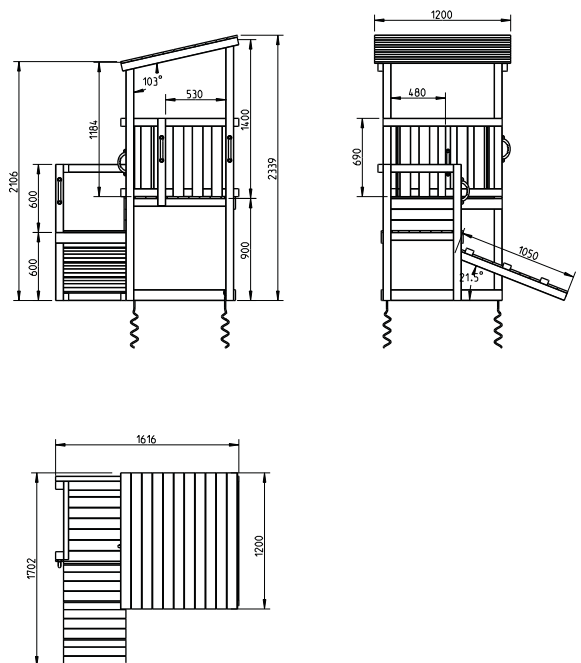
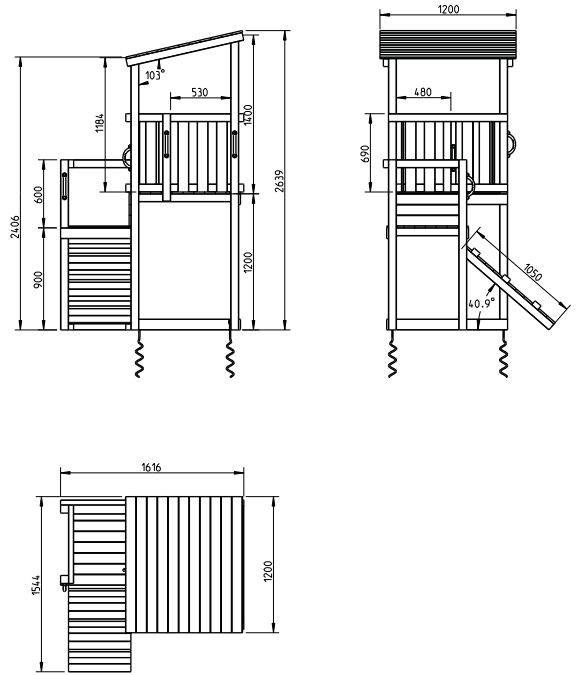
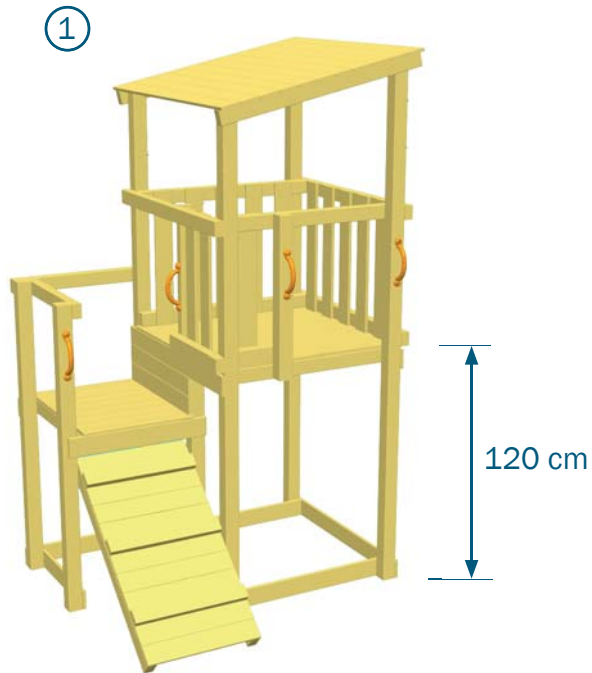
Blue Rabbit 2.0 - Hemelrijken 8 - B-2890 St-Amands - Belgium.  
Copyrighted material - Do not reproduce under penalty of law.

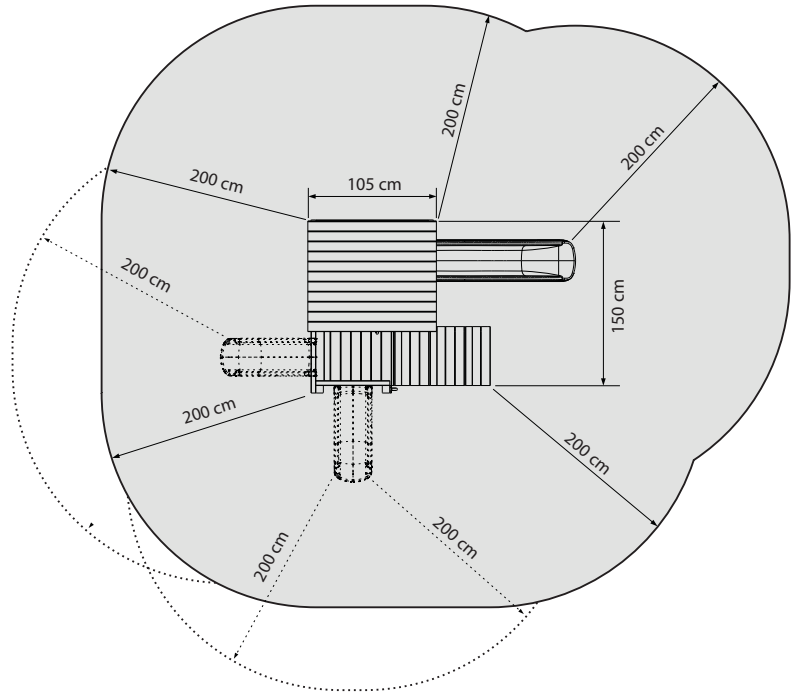
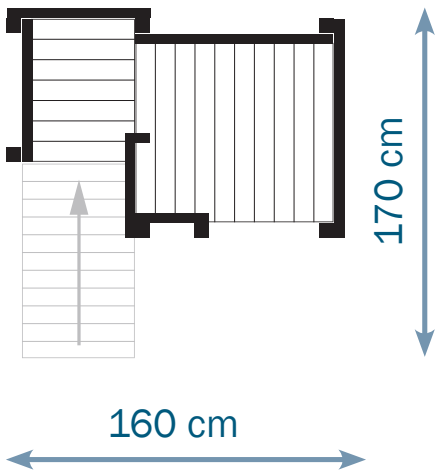

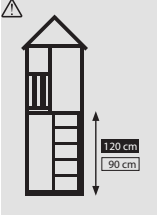
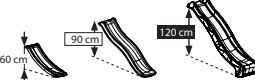

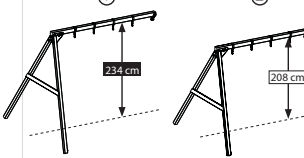
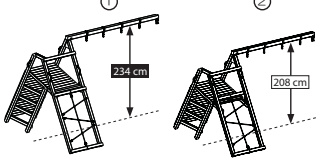
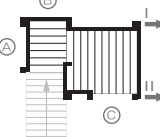
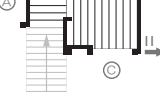
 <b>Cascade</b> 008.001.005.001	 <b>@platform</b> 008.003.006.001		 <b>@bridge</b> 008.003.004.001		 <b>@swing</b> 008.003.005.001		 <b>@challenger</b> 008.003.007.001		
	120 cm	90 cm	120 cm	90 cm	234 cm	208 cm	234 cm	208 cm	
	X	(A) (E)	(C)	→	⇌	(C)	⇌	⇌	⇌
	(A) (E)	(C)	X	X	X	X	X	⇌	⇌

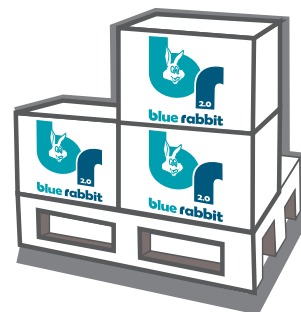

53 x 28 x 11 cm

5,5 kg



78

120 x 80 x 158 cm

454 kg

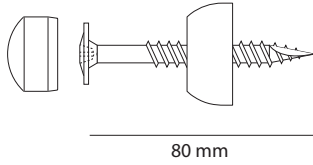
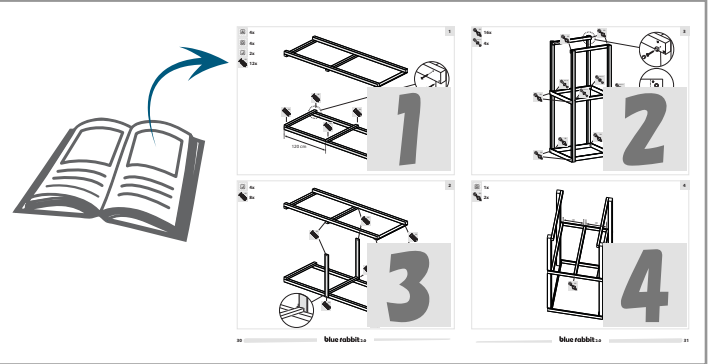
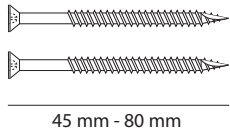
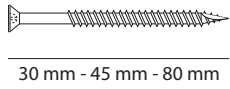
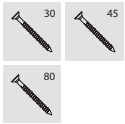

4x

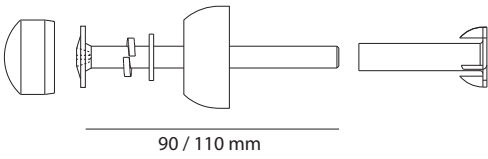

2x

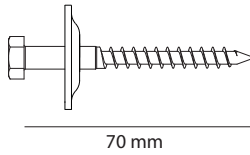

4x



2x



1x



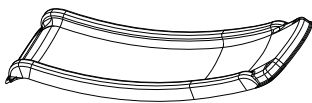

(1x)





(optional)





- 2x** **A** min 68 mm | max 90 mm  230 cm 260 cm

min 68 mm  
max 90 mm
- 2x** **B** min 68 mm | max 90 mm  210 cm 240 cm

min 68 mm  
max 90 mm
- 2x** **C** min 68 mm | max 90 mm  120 cm 150 cm

min 68 mm  
max 90 mm
- 1x** **D** min 68 mm | max 90 mm  90 cm 120 cm

min 68 mm  
max 90 mm
- 1x** **E** min 68 mm | max 90 mm  77 cm

min 68 mm  
max 90 mm
- 7x** **F** min 68 mm | max 90 mm  105 cm

min 32 mm  
max 50 mm
- 6x** **G** min 68 mm | max 90 mm  95 cm

min 32 mm  
max 50 mm
- 5x** **H** min 68 mm | max 90 mm  69 cm

min 32 mm  
max 50 mm
- 3x** **I** min 68 mm | max 90 mm  min 51 / max 55 cm

min 32 mm  
max 50 mm
- 1x** **J** min 68 mm | max 90 mm  50 cm

min 32 mm  
max 50 mm
- 1x** **K** min 68 mm | max 90 mm  min 32 cm  
max 35 cm

min 32 mm  
max 50 mm
- 8x\*/11x\*\*** **L** \*\* min 95 mm | \* max 145 mm  120 cm

min 15 mm  
max 22 mm
- 4x** **M** min 95 mm | max 145 mm  105 cm

min 15 mm  
max 22 mm
- 2x** **N** min 95 mm | max 145 mm  95 cm

min 15 mm  
max 22 mm
- 7x\*/11x\*\*** **O** \*\* min 95 mm | \* max 145 mm  min 87 / max 91 cm

min 15 mm  
max 22 mm
- 16x\*/19x\*\*** **P** \*\* min 95 mm | \* max 145 mm  69 cm

min 15 mm  
max 22 mm
- 11x\*/17x\*\*** **Q** \*\* min 95 mm | \* max 145 mm  min 51 / max 55 cm

min 15 mm  
max 22 mm

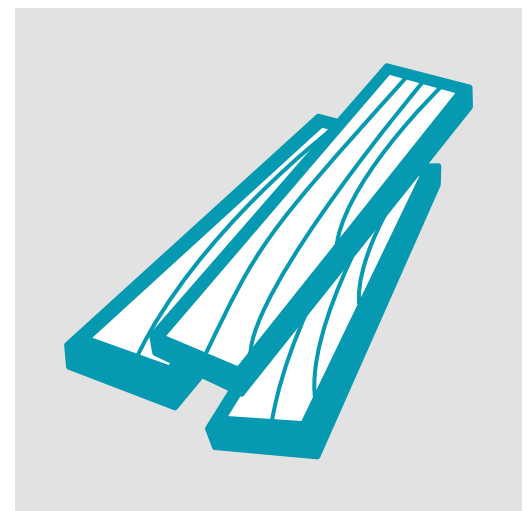
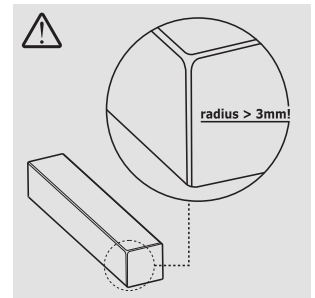
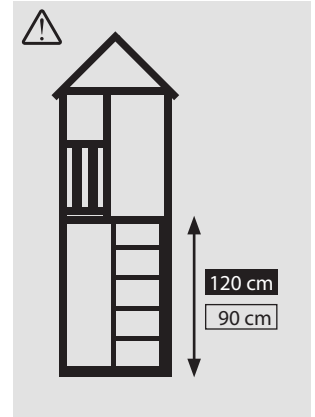



Blue Rabbit 2.0®  
Hemelrijken 8  
B-2890 Sint-Amands  
BELGIUM

[info@bluerabbit.be](mailto:info@bluerabbit.be)

[www.bluerabbit.be](http://www.bluerabbit.be)