



Penthouse

008.001.002.001



blue rabbit

© 2014

Blue Rabbit 2.0 - Hemelrijken 8 - B-2890 St-Amands - Belgium.
Copyrighted material - Do not reproduce under penalty of law.



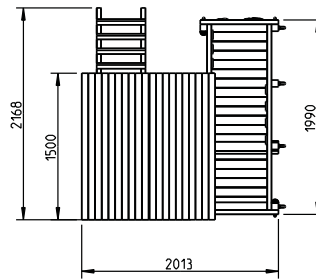
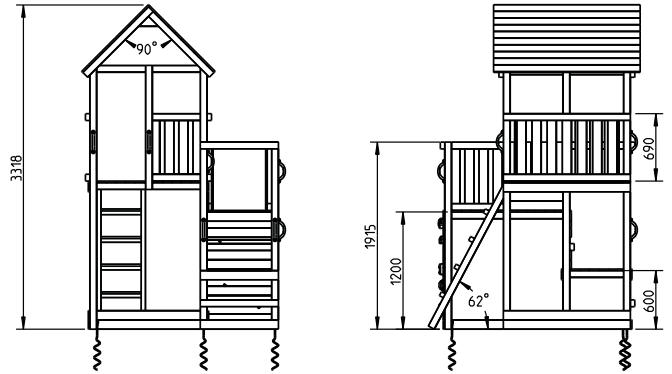
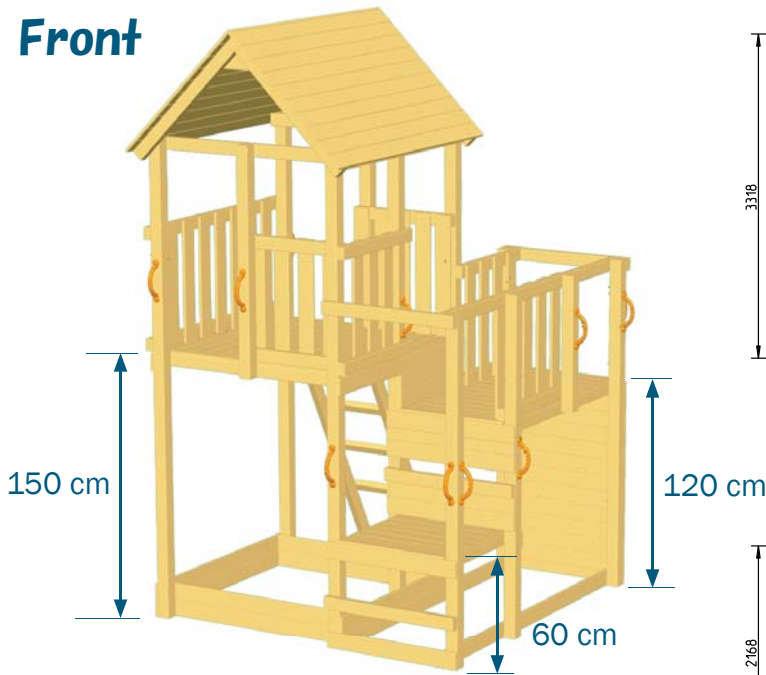



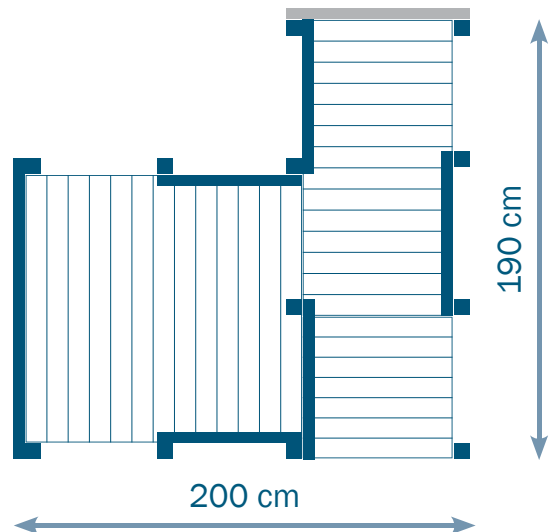

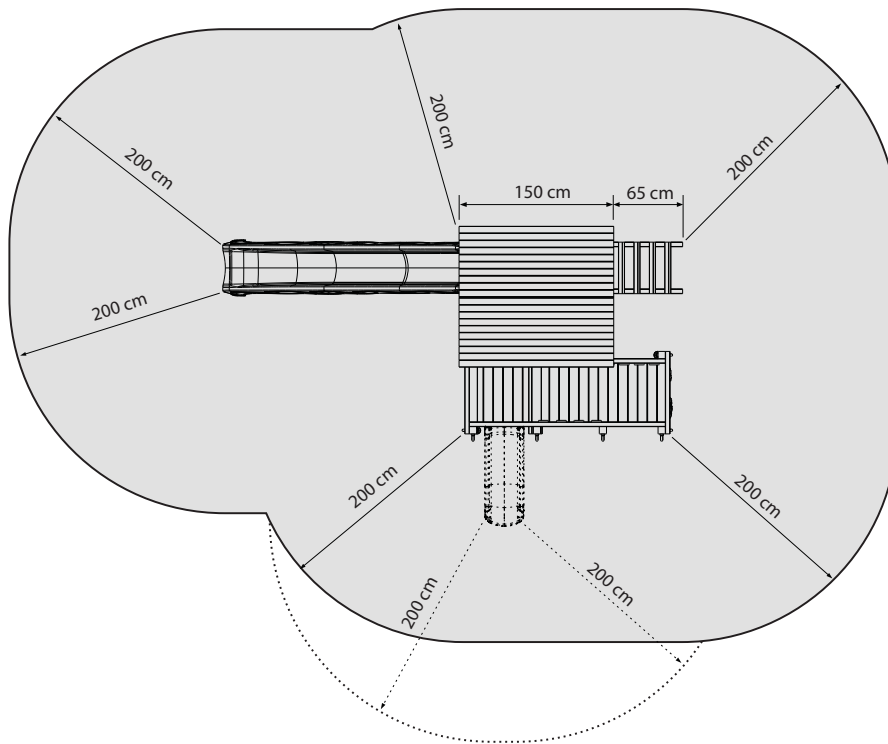
Front

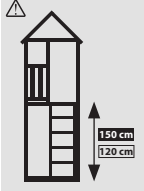
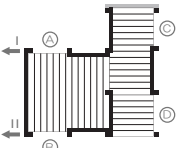

Back



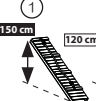

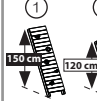
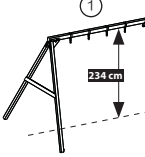
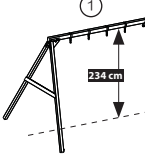
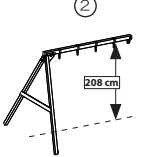

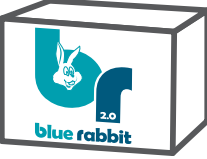
 Penthouse 008.001.002.001			@platform 008.003.006.001	@bridge 008.003.004.001	@net 008.003.003.001	@ramp 008.003.002.001	@wall 008.003.001.001	@swing 008.003.005.001				
												
	C	D	A, E	← X	A, B, C, D	A, B, C	A, E	C	A, E	C	← I II	X



?



53 x 28 x 19 cm

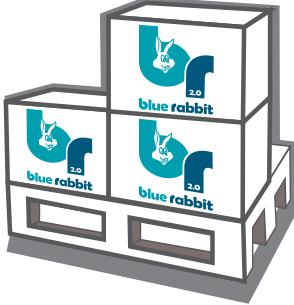

11,5 kg



?.x

42

120 x 80 x 148 cm

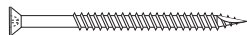

508 kg



30 mm - 45 mm - 80 mm

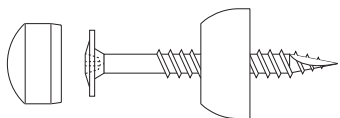

45 mm - 80 mm



80 mm

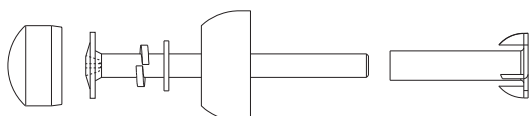

90 / 110 mm

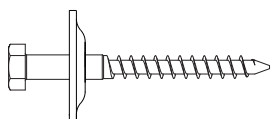

70 mm



40 mm

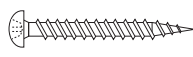

30 mm

13x









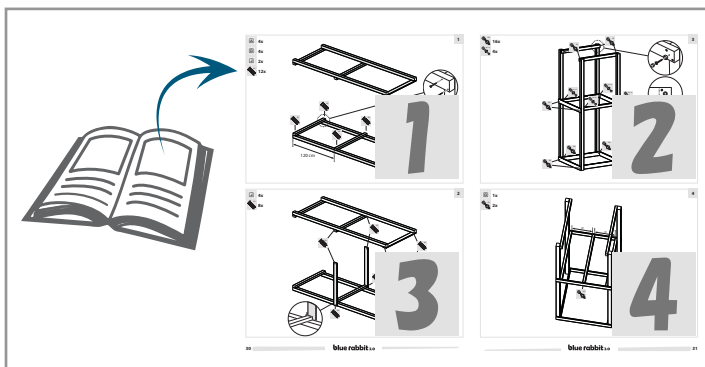









3x



1x



5x	A	min 68 mm max 90 mm		270 cm
		min 68 mm max 90 mm		
4x	B	min 68 mm max 90 mm		192 cm
		min 68 mm max 90 mm		
2x	C	min 68 mm max 90 mm		127 cm
		min 68 mm max 90 mm		
1x	D	min 68 mm max 90 mm		77 cm
		min 68 mm max 90 mm		
1x	E	min 68 mm max 90 mm		190 cm
		min 32 mm max 50 mm		
2x	F	min 68 mm max 90 mm		166 cm
		min 32 mm max 50 mm		
2x	G	min 68 mm max 90 mm		130 cm
		min 32 mm max 50 mm		
2x	H	min 68 mm max 90 mm		min 128 / max 130 cm
		min 32 mm max 50 mm		
6x	I	min 68 mm max 90 mm		120 cm
		min 32 mm max 50 mm		
2x	J	min 68 mm max 90 mm		95 cm
		min 32 mm max 50 mm		
2x	K	min 68 mm max 90 mm		min 86 / max 88 cm
		min 32 mm max 50 mm		
4x	L	min 68 mm max 90 mm		80 cm
		min 32 mm max 50 mm		
1x	M	min 68 mm max 90 mm		71 cm
		min 32 mm max 50 mm		
4x	N	min 68 mm max 90 mm		69 cm
		min 32 mm max 50 mm		
1x	O	min 68 mm max 90 mm		min 67 / max 69 cm
		min 32 mm max 50 mm		
1x	P	min 68 mm max 90 mm		63 cm
		min 32 mm max 50 mm		
4x	Q	min 68 mm max 90 mm		min 61 / max 63 cm
		min 32 mm max 50 mm		

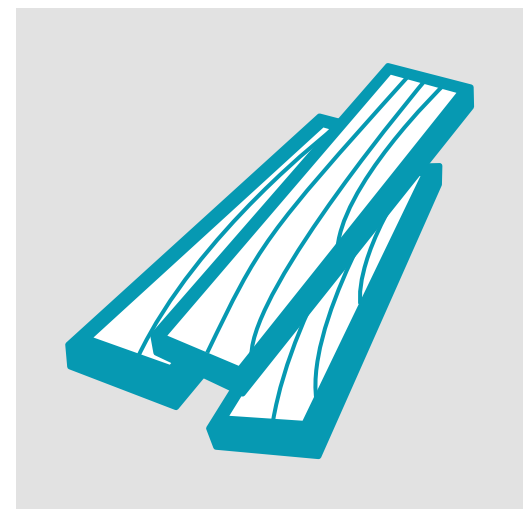
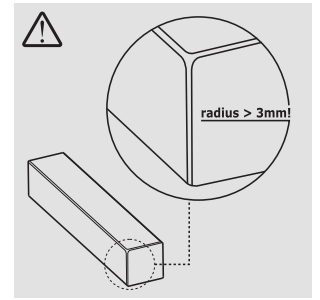

4x **R** min 44 mm | max 45 mm  50 cm

min 44 mm
max 45 mm

2x **S** min 95 mm | max 145 mm  190 cm

min 15 mm
max 22 mm

14x*/20x** **T** ** min 95 mm | * max 145 mm  150 cm

min 15 mm
max 22 mm

6x **U** min 95 mm | max 145 mm  130 cm

min 15 mm
max 22 mm

4x **V** min 95 mm | max 145 mm  120 cm

min 15 mm
max 22 mm

8x*/12x** **W** ** min 95 mm | * max 145 mm  min 112 / max 116 cm

min 15 mm
max 22 mm

17x*/21x** **X** ** min 95 mm | * max 145 mm  80 cm

min 15 mm
max 22 mm

17x*/26x** **Y** ** min 95 mm | * max 145 mm  69 cm

min 15 mm
max 22 mm

15x*/22x** **Z** ** min 95 mm | * max 145 mm  min 62 / max 66 cm

min 15 mm
max 22 mm

1x*/2x** **1** ** min 95 mm | * max 145 mm  64 cm



min 15 mm
max 22 mm

1x **2** min 95 mm | max 145 mm  min 51 / max 55 cm

min 15 mm
max 22 mm

1x **3** min 95 mm | max 145 mm  min 52 / max 54 cm

min 15 mm
max 22 mm

2x **4** min 95 mm | max 145 mm   40 cm
min 15 mm
max 22 mm

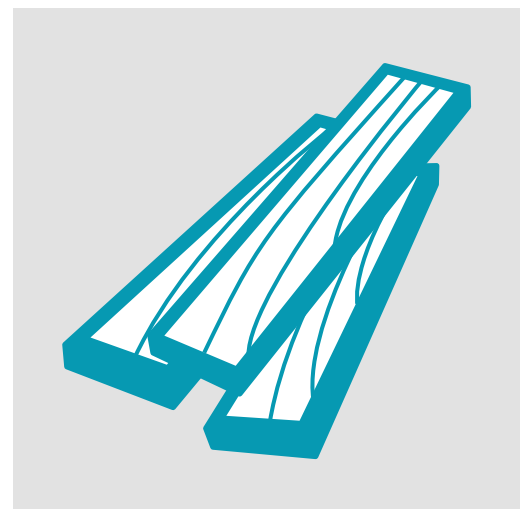
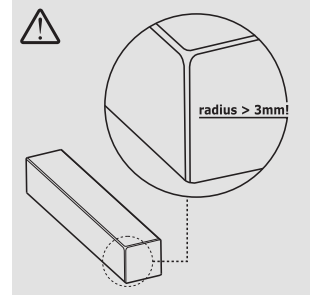



Blue Rabbit 2.0®
Hemelrijken 8
B-2890 Sint-Amands
BELGIUM

info@bluerabbit.be

www.bluerabbit.be